

PROPORTIONAL PRESSURE CONTROL VALVES AND SYSTEMS

www.elwood.com

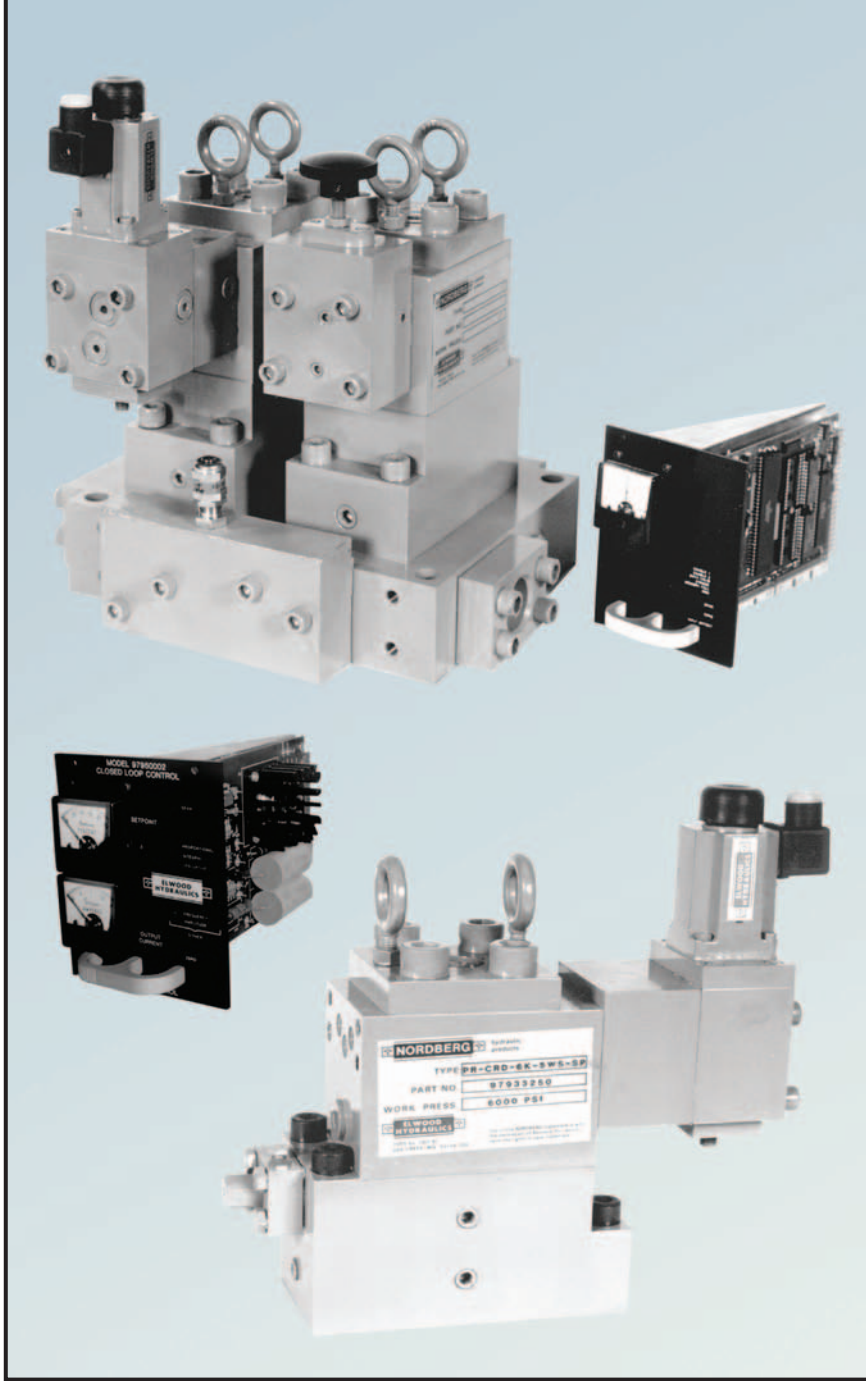

Proportional Pressure Control Valves

The Elwood Proportional Pressure Control Valves are pilot operated Relief and Reducing Valves utilizing the spindle design. The valves have a three piece construction consisting of a top plate, upper body and lower body. The valves also contain a spindle, reversible-replaceable seat, a four position orifice plug and a pilot head with proportional force controlled solenoid.

REDUCER

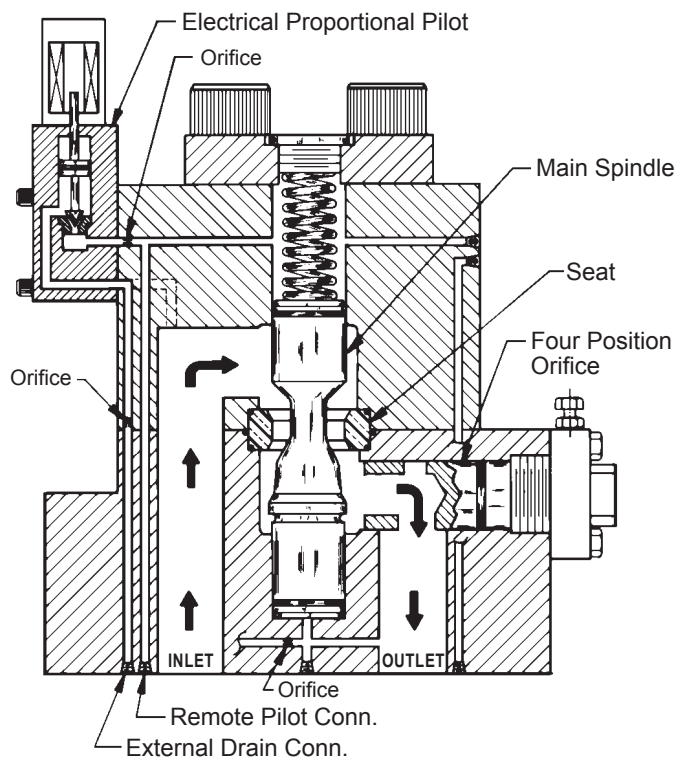

System pressure is adjusted in relationship to a current signal to the proportional solenoid. For the valve's pressure setting, a pressure balance on the main spindle allows the spring to hold the valve in a closed position (relief valve) or an open position (reducing valve) - refer to valve cutaways above. When system pressure working on the pilot poppet exceeds the solenoid force, a pilot flow is established to the external drain. This pilot flow creates a differential force on the main spindle because of a pressure drop through the orifices installed in the pilot.

RELIEF

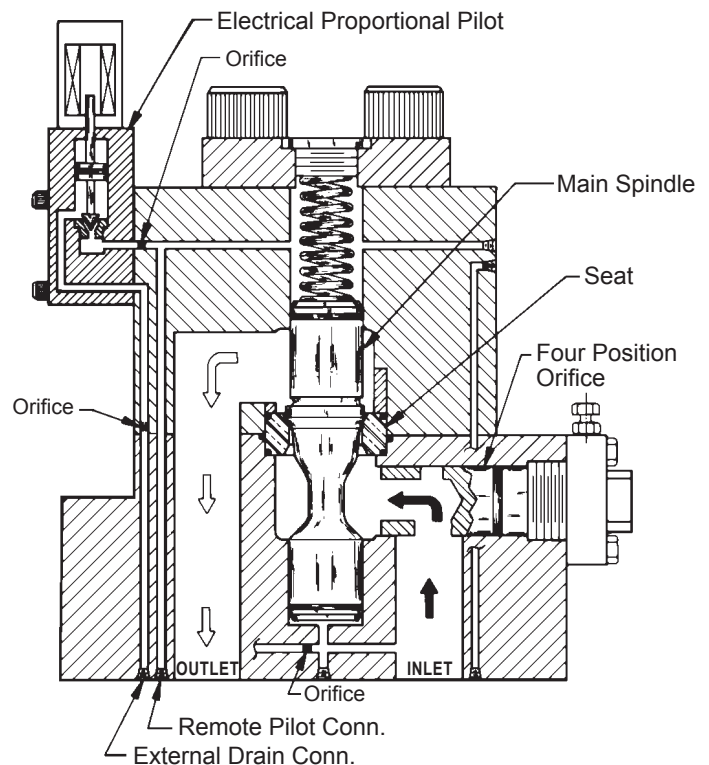

An electronic amplifier card, or adaptive control module, controls the current to the proportional solenoid in relationship to a control voltage (0 to +10V). The amplifier card is available as "Open Loop" or "Closed Loop" (with use of a pressure transducer). The "Adaptive Control Module" is used in closed loop when extreme accuracy is required.

NOTE: The adjustable orifice plug allows a pre-pressure drop to occur in the valve allowing the main spindle to create a larger opening in the sealing area, adding to the life of the valve.

Technical Data

		REDUCER	RELIEF		
HYDRAULICS	Maximum Operating Pressure				
	Hydraulic Media	HWCF, 97/3 Soluble Oil in Water, Synthetics, Mineral Oils and Kerosene			
	Viscosity Range at 100° F (38° C)	20 SSU (1.2 Cst.) - 1800 SSU (385 Cst.)			
	Maximum Pressure Rating	3 RATINGS 1500 PSI (103 bar), 3000 PSI (207 bar), 5000 PSI (345 bar)			
	Minimum Set Pressure @ Pressure Rating: 1500 PSI (103 bar) 3000 PSI (207 bar) 6000 PSI (414 bar)	250 PSI (17 bar) 250 PSI (17 bar) 500 PSI (34 bar)	300 PSI (20 bar) 450 PSI (31 bar) 550 PSI (38 bar)		
	Sizes	Flow Rate - GPM (LPM)			
	@ 3000 PSI (207 bar)	Nominal	Maximum	Nominal	Maximum
	A - 1/2"	11 (42)	15 (57)	15 (57)	20 (76)
	C - 3/4"	30 (114)	50 (190)	60 (227)	85 (322)
	D - 1 1/4"	80 (303)	120 (455)	125 (473)	190 (719)
	@ 2500 PSI (172 bar)	180 (681)		200 (757)	
	E - 2"	250 (946)		300 (1136)	
	Maximum Pressure for "E" Valve is 5000 PSI (345 bar)	Note: At 5000 PSI (345 bar), line size must be larger for maximum flow			
	Fluid Temperature Range	HWCF – 35 to 150° F (2 to 66° C) Mineral Oil – 5 to 150° F (-15 to 66° C)			
Recommended Filtration	50 - 60 Micron Pilot Filter provided				
Repeatability	Closed Loop with Dither ± 10% Closed Loop with Dither ± 0.5% (± 0.07% with Electronic Adaptive Control)				
Hysteresis (test data for "C" size valve)	with Dither ± .5%				
Response Time / Step Change (test data for "C" size valve)	800 - 2500 PSI (55 - 172 bar) 800 - 1500 PSI (55 - 103 bar) 400 - 800 PSI (28 - 55 bar)				
Drain Flow @ 3000 PSI (207 bar)	0.5 GPM (LPM)				
ELECTRICAL	Type of Supply	Direct Current (DC)			
	Minimum Control Current	#16 Solenoid	#20 Solenoid		
		(3000 PSI) 150 ma	(6000 PSI) 175 ma		
	Maximum Control Current	1400 ma	1600 ma		
	Coil Resistance	10.6 ohms			
	Coil Rating	Continuous			
	Maximum Ambient Temperature	175° F (79° C)			
Electrical Connection Insulation	Hirshmann Type DIN 43650 Exceeds NEMA Class B Requirements				

Solenoid Power Draw Curve

INPUT CURRENT VS. PRESSURE

Model C, 3000 PSI, Size 16 Solenoid

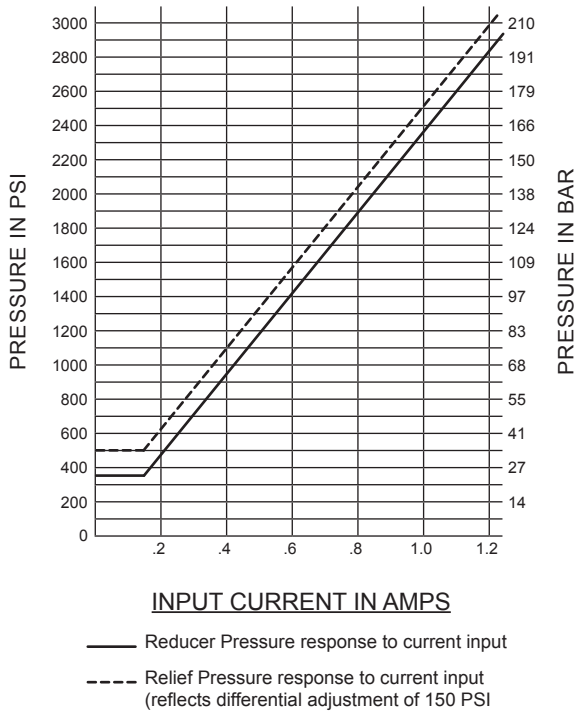

TYPICAL VALVE RESPONSE Current Input From Sq. Wave Gen.

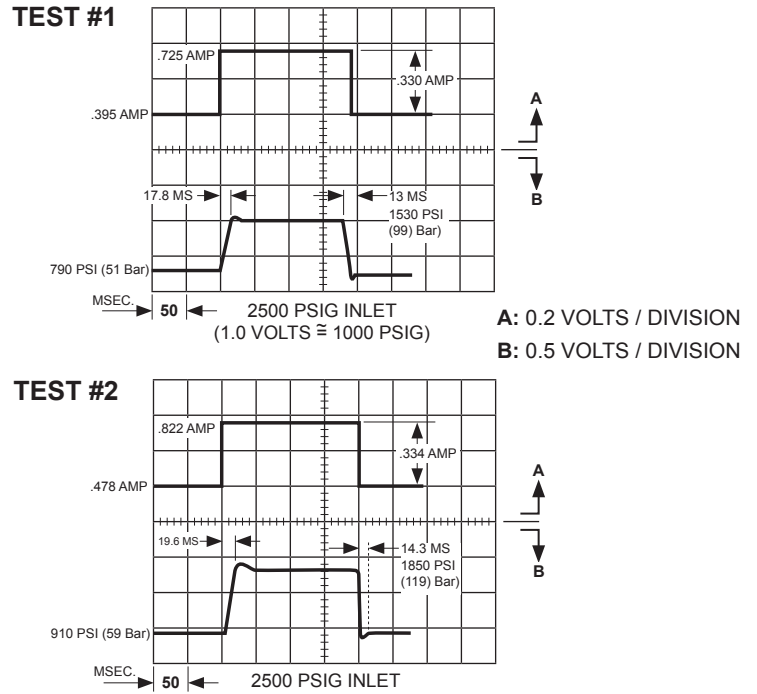

Note: Test data shown is with a “C” size reducer at 2500 PSI.

CIRCUIT: The test results shown reflect the pressure response of the “C” size Proportional Reducer/Relief Assembly reacting on a three gallon volume of fluid. The input current was supplied in a square wave form from a frequency generator.

RESULTS: The above graphs illustrate the current (Channel A) and pressure (Channel B) wave forms as displayed on a storage type oscill scope.

NOTE: It is recommended that the hydraulic supply pressure be maintained at a level of 15% higher than the maximum set pressure to obtain optimum performance from the valve.

Dimensional Data

Dual Package

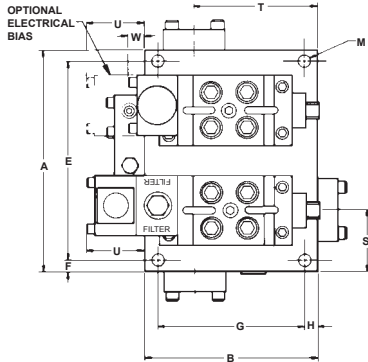

PR-CRD/CRL		
	inch	mm
A	8.75	222.3
B	11.0	279.4
C	19.5	495.3
D	14.5	368.3
E	7.5	190.5
F	0.62	15.9
G	9.88	250.9
H	0.56	14.3
J	1.25	31.8
K	2.50	65.5
L	1.0	25.4
M	0.65	16.7
N	6.5	165.1
O	3.0	76.2
P	3.5	88.9
R	6.0	152.4
S	3.0	76.2
T	6.0	152.4
U	2.75	69.9
W	0.75	19.1

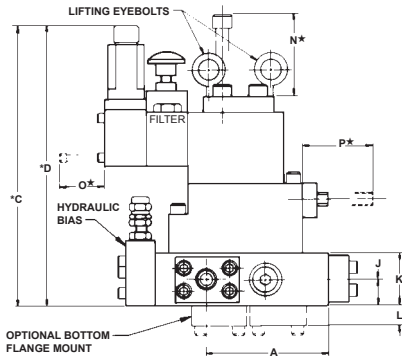

★ Required for Removal
 *C: 5000 PSI (345 Bar) model
 *D: 1500 PSI (105 Bar) & 3000 PSI (210 Bar) models

Single Valve

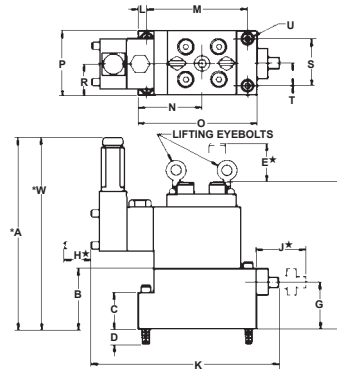

	MODEL C		MODEL D		MODEL E	
	inch	mm	inch	mm	inch	mm
A	12.0	304.8	14.0	355.6	16.5	419.1
B	3.5	88.9	4.5	114.3	6.0	152.4
C	2.0	50.8	3.0	76.2	6.0	152.4
D	0.88	22.2	1.25	31.8	1.5	38.1
E	6.5	165.1	7.0	177.8	7.5	190.5
F	8.4	213.4	10.8	274.3	14.5	368.3
G	2.7	68.8	3.4	86.4	4.3	109.2
H	3.0	76.2	3.0	76.2	3.0	76.2
J	3.5	88.9	5.0	127.0	6.0	152.4
K	11.2	284.5	13.6	345.4	16.1	408.9
L	0.44	11.2	0.75	19.1	0.88	22.2
M	5.62	142.7	8.0	203.2	10.5	266.7
N	3.44	87.4	5.0	127.0	6.38	162.1
O	6.5	165.1	9.5	241.3	12.3	312.4
P	3.5	88.9	4.5	114.3	6.0	152.4
R	1.75	44.5	2.25	57.2	3.0	76.2
S	2.25	57.2	3.0	76.2	3.75	95.3
T	1.12	28.4	1.5	38.1	1.88	47.6
U	1/2-13 UNC		3/4-10 UNC		1-8 UNC	
W	17.0	431.8	19.0	482.6	21.5	546.1

★ Required for Removal
 *C: 5000 PSI (345 Bar) model
 *D: 1500 PSI (105 Bar) & 3000 PSI (210 Bar) models

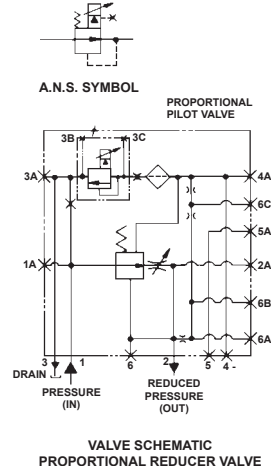
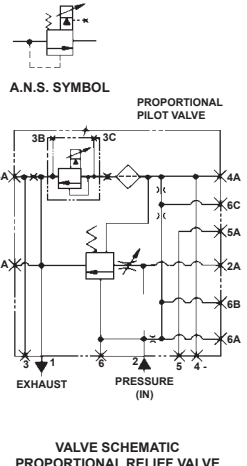
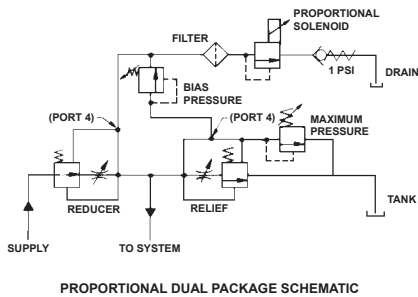

Open Loop Control

Description:

The Model 9795-0003 accepts command signals in several formats and provides current to operate the valve solenoid. The module is equipped with an integral power supply operating from line voltage.

An analog meter indicates the command signal in percent and an analog meter indicates the output current in amperage. The Model 9795-0003 provides output current proportional to the command signal.

The Model 9795-0003 can be sub-panel mounted utilizing the Model 9795-0006 enclosure or may be rack mounted using the Model 9795-0007 enclosure.

SPECIFICATIONS	
Supply Voltage	120/240 Volts, 50/60Hz, 2/1 Amps
Output Current	0 to 2 Amps
Panel Potentiometer	1 turn (270°) 5,000 ohm
Remote Potentiometer	10 turn, 5,000 ohm
External Voltage Command	0-10 volts
CMRR	60Db at 60Hz
Common mode voltage	5 volts
External Current Command	0-50 milliamps
Frequency Response	20 Kilohertz
Command signal analog meter	0 to 100 percent
Output current analog meter	0 to 2 Amps
Power on	LED indicator
Size	5.25" H x 4.25" W x 8" D

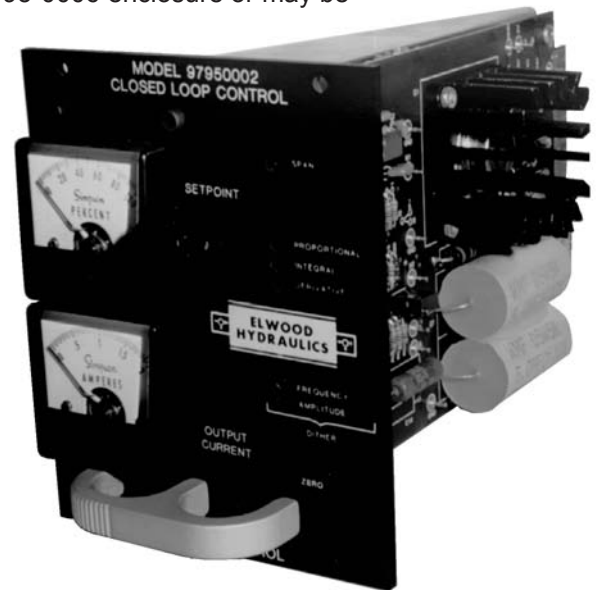

Closed Loop Control

Description:

The Model 9795-0002 accepts a command signal and provides current to operate the valve solenoid. The module is equipped with an integral power supply operating from line voltage.

An analog meter indicates the command signal in percent and an analog meter indicates the output current in amperage. The Model 9795-0002 provides a flow proportional to the command signal.

The Model 9795-0002 can be sub-panel mounted utilizing the Model 9795-0006 enclosure or may be rack mounted using the Model 9795-0007 enclosure.

SPECIFICATIONS	
Supply voltage	120/240 Volts, 50/60Hz, 2/1 Amps
Output Current	0 to 2 Amps Command
SIGNAL	
Panel Potentiometer	1 turn (270°) 5,000 ohm
Remote Potentiometer	10 turn, 5,000 ohm
External Voltage Command	0-10 volts
CMRR	60Db at 60Hz
Common mode voltage	5 volts
External Current Command	0-50 milliamps
Resolution	1 PSI
Frequency Response	20 Kilohertz
PRESSURE TRANSDUCER	
Excitation	10 Vdc
Input Sensitivity	30 mV full scale
AUXILIARY OUTPUT	
Pressure	0-10 Vdc full scale at 5 mA
INDICATORS	
Command signal analog meter	0 to 100 percent
Output current analog meter	0 to 2 Amps
Power on	LED indicator
Size	5.25" H x 4.25" W x 8" D

Ordering Data Proportional Pressure Control

ELWOOD®

**FLUID
POWER**

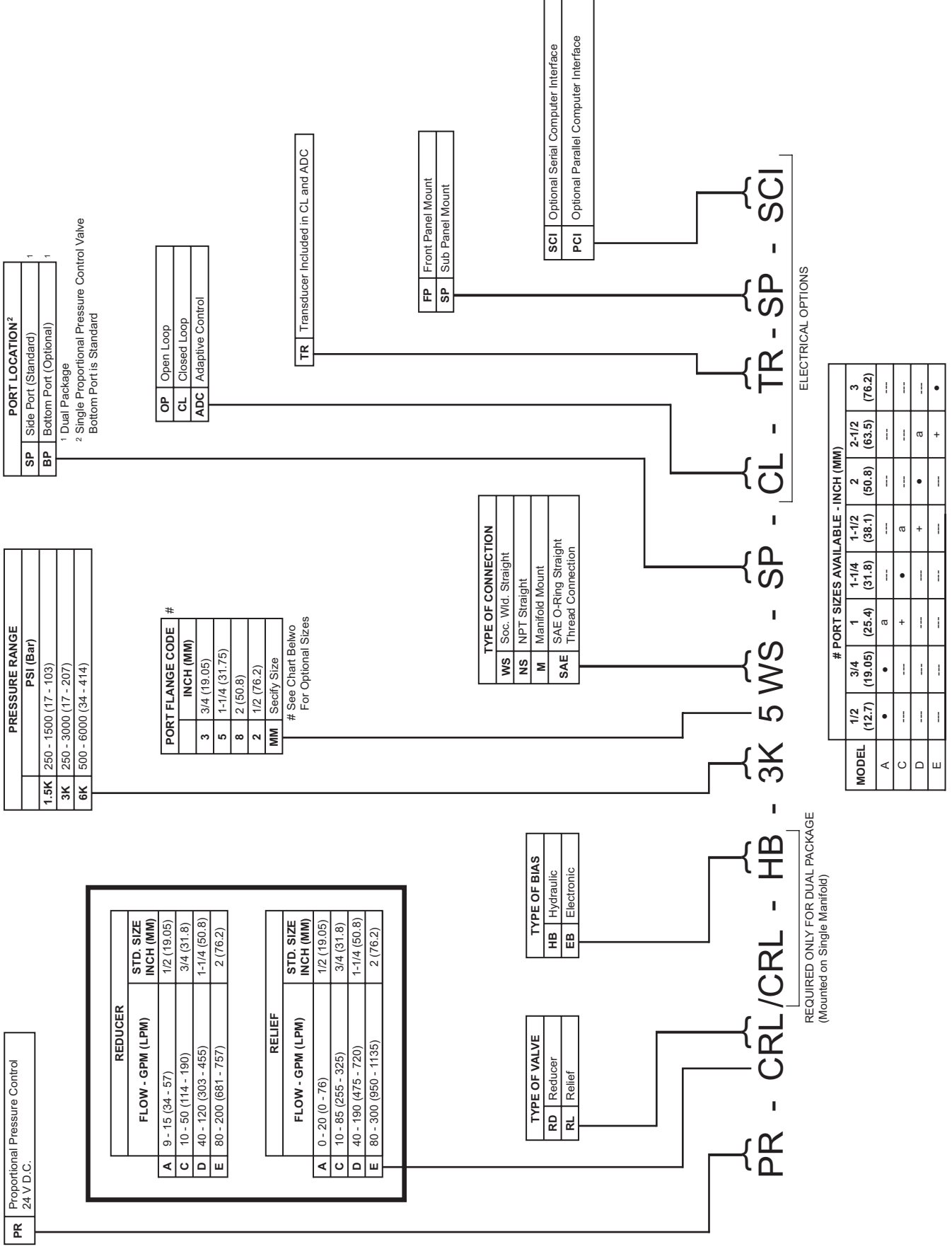

Packed Spool Directional Control Valves

- Directional Valve for a range of applications
- Up to 46 GPM (32 GPM nominal)
- 3000 PSI (207 bar) and 6000 PSI (414 bar)

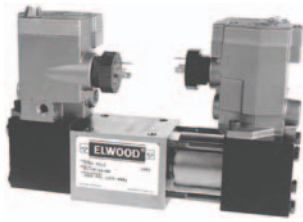

- Air Solenoid Operated
- 3-position spring centered
- 2-position spring offset
- 2-position momentary contact

Brochure 82

Poppet Type Directional Control Valves

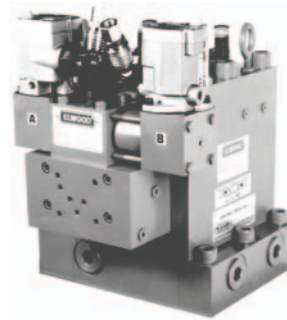

- Capacities to 1600 GPM (6057 LPM)
- 3000 PSI (207 bar), 4500 PSI (310 bar) and 6000 PSI (414 bar) models are available
- Built-in flow control
- Manifold mounted, NPT, socket weld or flanged

Brochure 395

Proportional Pressure Control System

Controlled Pressure Ranges:

390 PSI (27 bar) to 1500 PSI (103 bar)
 480 PSI (33 bar) to 3000 PSI (207 bar)
 580 PSI (40 bar) to 6000 PSI (414 bar)
 FLOW RATE: To 1000 GPM (3785 LPM)

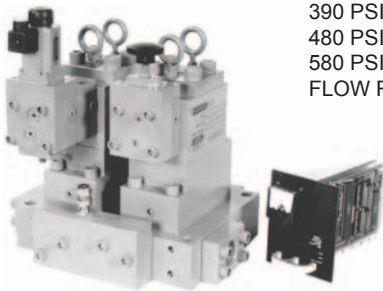

Brochure 104

Modular ISO-Lock

- Isolates manifold mounted directional control valves
- Reduces maintenance time - replace Directional Valves without depressurizing and draining hydraulic system.
- Single lever operation to close all four ports (P, T, A, B). Cylinders can remain under the external load without having to be blocked.
- Lockable per OSHA safety standard
- NFPA "DO"/CETOP and special mounting patterns available



Brochure 250

Descaling & Pump Unloading Valves

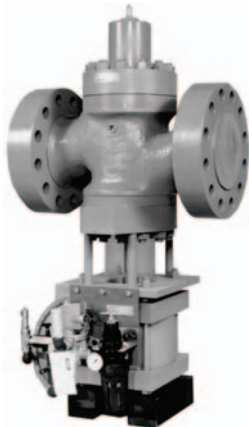

Capacities:

3000 PSI (207 bar)
 6000 PSI (414 bar)
 6000 GPM (22710 LPM)

Connection Sizes: 1-1/4" to 10"

Descaling Valves - Spindle – Brochure 2218
 DIN – Brochure 2219

Pump Unloading Valves – Brochure 2213

Accumulator Systems

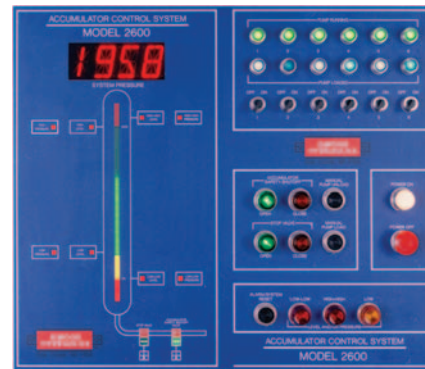

- Descaling
- Mill Systems
- Presses
- Controls
 - Level
 - Pressure
 - Pump Sequencing
 - Ballast Charging
- Designed to your specifications

Brochures 102, 105 & 380



ELWOOD CORPORATION

195 West Ryan Road • Oak Creek, Wisconsin 53154 • USA

Phone: 800-527-7500 • Fax: 414-764-4298

www.elwood.com

3/06 - Brochure 104

Rev. A